

SOLID FIBERGLASS COVER

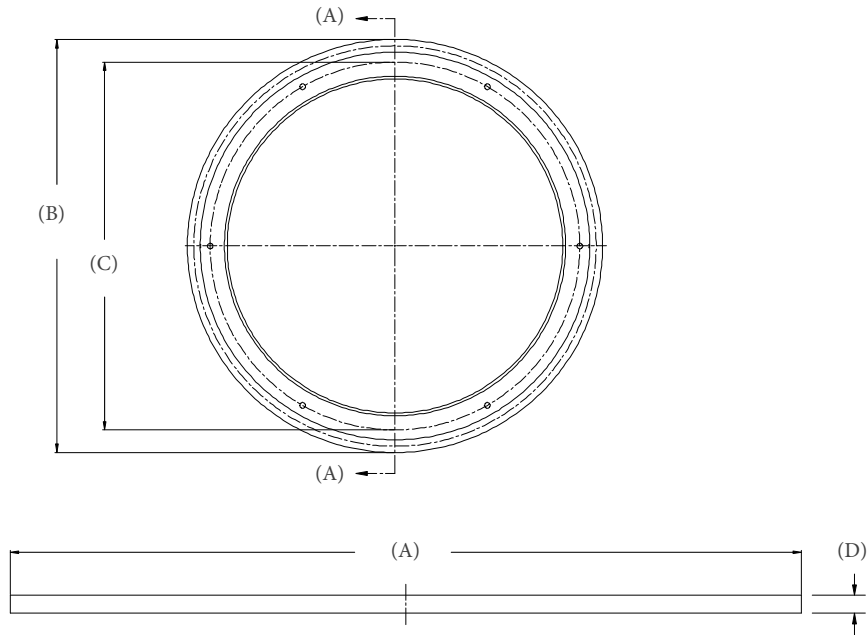

	Ⓐ	Ⓑ	Ⓒ	Ⓓ
PART NO.	BASIN INSIDE DIM.	OUTSIDE DIM.	BOLT CIRCLE	THICKNESS
C36WF-TRD	36	42-1/2"	38-1/2"	13/16"

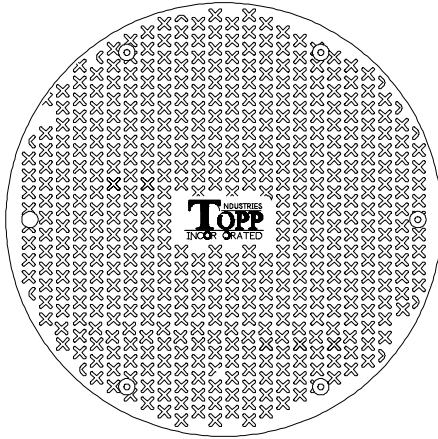

Scale: None
 Drawn By: RM
 App'd By:
 Date:

This print is and contains confidential proprietary information owned exclusively by TOPP INDUSTRIES, INC. It is furnished on a strictly confidential basis. This restriction includes, but is not limited to the condition that this print will not only be used as a record or to identify or inspect parts or for other information purposes and will not be used to manufacture or procure the manufacture of the items shown in this print by any other source than TOPP INDUSTRIES, INC.

Highway 25 North P.O. Box 480
 Rochester, IN 46975
 Phone: 800/354-4534 Fax: 574/223-6106

08-22-13