

10ENH SERIES - 1/2 HP

APPLICATIONS

Effluent wastewater removal, dewatering, water transfer

FEATURES

- Permanent Split Capacitor (PSC)
- Designed for continuous duty
- Energy-saving low amp draw
- 1-1/2" FNPT (38 mm) discharge
- Handles solids up to 3/4" (19 mm) diameter
- Multiple switch options for automatic operation
- 140 °F (60 °C) liquid temperature rating
- cCSAus listed



SERIES SPECIFICATIONS

Volts	Hz	Amps		Watts	Performance (GPM @ Height in Feet)					Shut-Off (ft)	PSI
		FLA	Start		5'	10'	20'	30'	40'		
115	60	9.5	16	1045	60	52	42	30	18	60	26
208-230	60	5	8.2	750	60	52	42	30	18	50	21.6

Item No.	Model	HP	Volts	Switch Type/ Operation	On Level	Off Level	Cord	Weight
511602	10ENH-CIA-SFS	1/2	115	Integral Float Switch	9" - 14" 22.86 cm - 35.56 cm	2" - 6" 5 cm - 15.24 cm	20' 6.1 m	38 lbs 17.24 Kg
511603	10ENH-CIA-SFS	1/2	115	Integral Float Switch	9" - 14" 22.86 cm - 35.56 cm	2" - 6" 5 cm - 15.24 cm	30' 9.1 m	39 lbs 17.69 Kg
511573	10ENH-CIA-RF	1/2	115	Piggyback Float Switch	9" - 12" 22.86 cm - 30.48 cm	3" - 6" 7.62 cm - 15.24 cm	20' 6.1 m	38 lbs 17.24 Kg
511574	10ENH-CIA-RF	1/2	115	Piggyback Float Switch	9" - 12" 22.86 cm - 30.48 cm	3" - 6" 7.62 cm - 15.24 cm	30' 9.1 m	39 lbs 17.69 Kg
511571	10ENH-CIM	1/2	115	Manual	-	-	20' 6.1 m	37 lbs 16.78 Kg
511572	10ENH-CIM	1/2	115	Manual	-	-	30' 9.1 m	38 lbs 17.24 Kg
511577	10ENH-CIA-RF	1/2	208-230	Piggyback Float Switch	9" - 12" 22.86 cm - 30.48 cm	3" - 6" 7.62 cm - 15.24 cm	20' 6.1 m	38 lbs 17.24 Kg
511578	10ENH-CIA-RF	1/2	208-230	Piggyback Float Switch	9" - 12" 22.86 cm - 30.48 cm	3" - 6" 7.62 cm - 15.24 cm	30' 9.1 m	39 lbs 17.69 Kg
511575	10ENH-CIM	1/2	208-230	Manual	-	-	20' 6.1 m	37 lbs 16.78 Kg
511576	10ENH-CIM	1/2	208-230	Manual	-	-	30' 9.1 m	38 lbs 17.24 Kg

EFFLUENT PUMPS

10ENH SERIES - 1/2 HP

ENGINEERING DATA

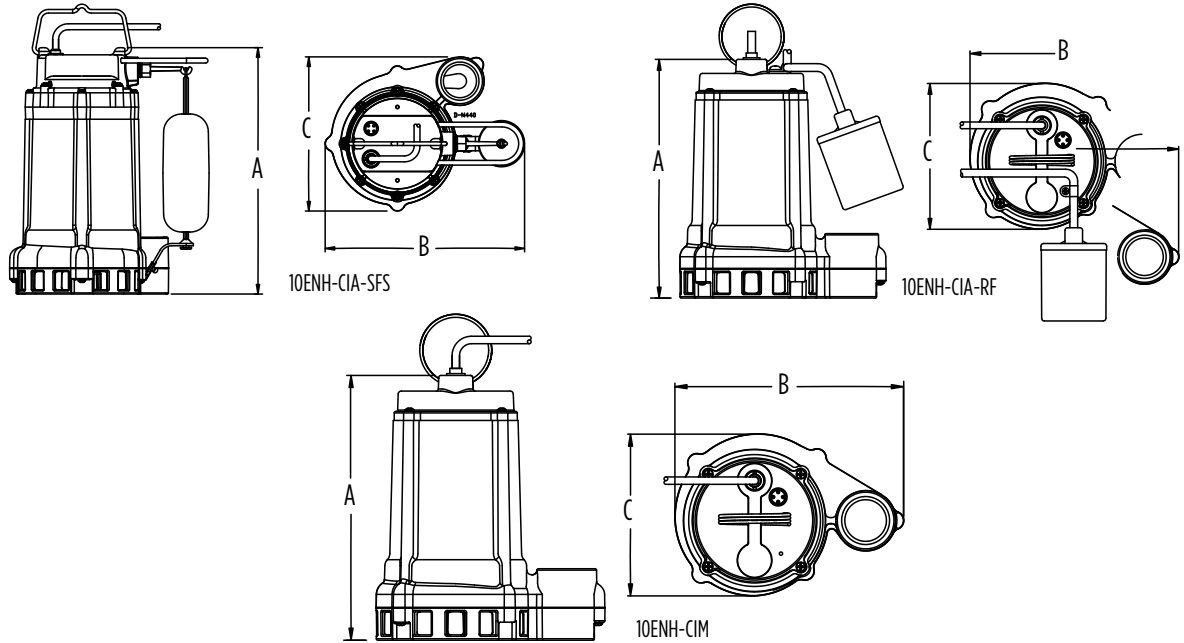

Model	A	B	C
10ENH-CIA-SFS	12.9" 32.77 cm	10.45" 26.54 cm	8.07" 20.50 cm
10ENH-CIA-RF	11.03" 28.02 cm	9.53" 24.21 cm	6.74" 17.12 cm
10ENH-CIM	11.03" 28.02 cm	9.53" 24.21 cm	6.74" 17.12 cm

PERFORMANCE DATA

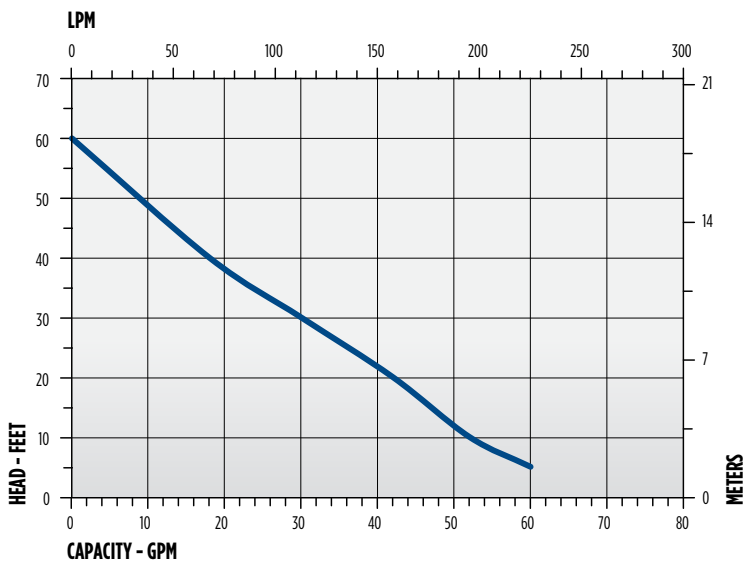

CONSTRUCTION

Cover	Epoxy-coated cast iron/ *Thermoplastic
Motor Housing	Epoxy-coated cast iron
Impeller Material	Thermoplastic elastomer
Impeller Type	Non-clog
Volute	Epoxy-coated cast iron
Mechanical Shaft Seal	Nitrile with carbon and ceramic faces
Fasteners	Stainless steel
Shaft	Steel
Bearings	Upper and lower ball bearing
Power Cord	SJTW **SJTOW

* On SFS models

** On 30' 10ENH-CIA-RF and 10ENH-CIM models